

Ideal for compressor  
and motor control  
Inrush 80A,  
1a 20A power relay

## JM RELAYS

### FEATURES

- Compact, high-capacity, and resistant to inductive loads**  
 It can control an inductive load with inrush current of 80 A and steady state current of 20 A.
- Excellent contact welding resistance**  
 High contact pressure, a forced opening mechanism, and a forced wiping mechanism realizes an excellent contact welding resistance.
- High breakdown voltage and surge resistant relay**  
 More than 6.4 mm .252 inch maintained for the insulation distance between contacts and coil, and the breakdown voltage between contacts and coil is 5,000 V for 1 minute. In addition, the surge resistance between contacts and coil is greater than 10,000 V.
- Resistant to external force**  
 An absorber mechanism is used on the load terminals, giving a large improvement in characteristics variations caused by the external force during FASTON placement/removal.
- Flux resistance mechanism**  
 The terminal area is plugged with resin to prevent flux seepage during PCB mounting. (TMP type)

- Conforms to the various safety standards**  
 UL, CSA, VDE available
- The line up can support economical mounting methods.**  
 The relay are equipped with a drive terminal (coil terminal) on one side for PCBs, and a load terminal (tab terminal #250) on the reverse side. The line up includes the TM type which can be attached directly to the PCB composing a drive circuit, and the TMP type which supports economical wiring. The TMP type can also be directly attached, and a high capacity load can be wired to the tab terminal.

### TYPICAL APPLICATIONS

- Compressor and heater control in air conditioners
- Power control in hot air type heaters
- Magnetron control in microwave ovens
- Lamp and motor control in OA equipment such as copiers and facsimiles.

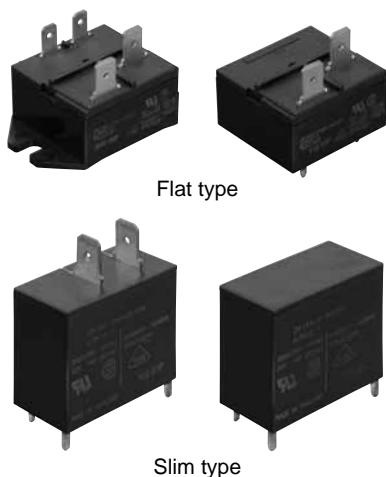

Flat type

Slim type

RoHS compliant

### ORDERING INFORMATION

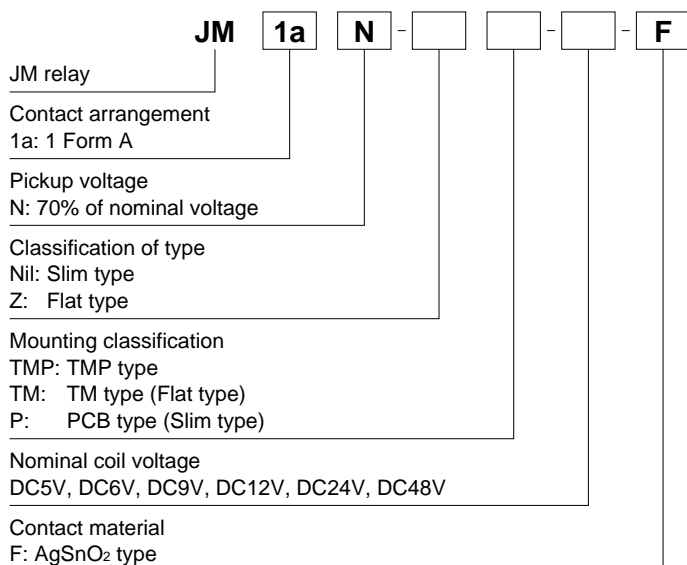

Note: Certified by UL, CSA and VDE

## TYPES

Nominal coil voltage	Part No.			
	TMP type (Flat)	TM type (Flat)	TMP type (Slim)	PCB type (Slim)
5V DC	JM1aN-ZTMP-DC5V-F	JM1aN-ZTM-DC5V-F	JM1aN-TMP-DC5V-F	JM1aN-P-DC5V-F
6V DC	JM1aN-ZTMP-DC6V-F	JM1aN-ZTM-DC6V-F	JM1aN-TMP-DC6V-F	JM1aN-P-DC6V-F
9V DC	JM1aN-ZTMP-DC9V-F	JM1aN-ZTM-DC9V-F	JM1aN-TMP-DC9V-F	JM1aN-P-DC9V-F
12V DC	JM1aN-ZTMP-DC12V-F	JM1aN-ZTM-DC12V-F	JM1aN-TMP-DC12V-F	JM1aN-P-DC12V-F
24V DC	JM1aN-ZTMP-DC24V-F	JM1aN-ZTM-DC24V-F	JM1aN-TMP-DC24V-F	JM1aN-P-DC24V-F
48V DC	JM1aN-ZTMP-DC48V-F	JM1aN-ZTM-DC48V-F	JM1aN-TMP-DC48V-F	JM1aN-P-DC48V-F

Standard packing: Carton 50 pcs., Case 200 pcs.

## RATING

## 1. Coil data

Nominal coil voltage	Pick-up voltage (at 20°C 68°F)	Drop-out voltage (at 20°C 68°F)	Nominal operating current [ $\pm 10\%$ ] (at 20°C 68°F)	Coil resistance [ $\pm 10\%$ ] (at 20°C 68°F)	Nominal operating power	Max. applied voltage (at 60°C 140°F)
5V DC	70%V or less of nominal voltage (Initial)	10%V or more of nominal voltage (Initial)	180 mA	27.8 $\Omega$	900mW	110%V of nominal voltage
6V DC			150 mA	40 $\Omega$		
9V DC			100 mA	90 $\Omega$		
12V DC			75 mA	160 $\Omega$		
24V DC			37.5 mA	640 $\Omega$		
48V DC			18.75mA	2,560 $\Omega$		

## 2. Specifications

Characteristics	Item	Specifications	
Contact	Contact material	AgSnO <sub>2</sub> type	
	Arrangement	1 Form A	
	Contact resistance (Initial)	Max. 100 m $\Omega$ (By voltage drop 6 V DC 1A)	
Rating	Nominal switching capacity (resistive load)	20A 250V AC	
	Max. switching power (resistive load)	5,000VA	
	Max. switching voltage	250V AC	
	Max. switching current	20A	
	Min. switching capacity (reference value)*1	100mA, 5V DC	
Electrical characteristics	Insulation resistance (Initial)	Min. 100M $\Omega$ (at 500V DC) Measurement at same location as "Breakdown voltage" section.	
	Breakdown voltage (Initial)	Between open contacts	1,000 Vrms for 1 min. (Detection current: 10 mA)
		Between contact and coil	5,000 Vrms for 1 min. (Detection current: 10 mA)
	Temperature rise (coil)	Max. 55°C 131°F (By resistive method, nominal coil voltage applied to coil: 100%V, contact carrying current: 20A, at 60°C 140°F)	
	Surge breakdown voltage*2 (Between contact and coil) (Initial)	10,000 V	
	Operate time (at nominal voltage) (at 20°C 68°F)	Max. 20 ms (excluding contact bounce time.)	
Release time (at nominal voltage) (at 20°C 68°F)	Max. 10 ms (excluding contact bounce time) (Without diode)		
Mechanical characteristics	Shock resistance	Functional	98 m/s <sup>2</sup> (Half-wave pulse of sine wave: 11 ms; detection time: 10 $\mu$ s.)
		Destructive	980 m/s <sup>2</sup> (Half-wave pulse of sine wave: 6 ms.)
	Vibration resistance	Functional	10 to 55 Hz at double amplitude of 1.6 mm (Detection time: 10 $\mu$ s.)
		Destructive	10 to 55 Hz at double amplitude of 2 mm
Expected life	Mechanical (at 180 times/min.)	Min. 10 <sup>6</sup>	
	Electrical (at 20 times/min.)	Min. 10 <sup>5</sup> (at nominal switching capacity)	
Conditions	Conditions for operation, transport and storage*3	Ambient temperature: -40°C to +60°C -40°F to +140°F, Humidity: 5 to 85% R.H. (Not freezing and condensing at low temperature)	
	Max. operating speed	20 times/min. (at nominal switching capacity)	
Unit weight	Slim TMP and Slim PCB: Approx. 28 g .99 oz Flat TMP: Approx. 30 g 1.06 oz Flat TM: Approx. 30 g 1.06 oz		

\* Specifications will vary with foreign standards certification ratings.

Notes: \*1. This value can change due to the switching frequency, environmental conditions, and desired reliability level, therefore it is recommended to check this with the actual load.

\*2. Wave is standard shock voltage of  $\pm 1.2 \times 50\mu$ s according to JEC-212-1981

\*3. The upper limit of the ambient temperature is the maximum temperature that can satisfy the coil temperature rise value. Refer to Usage, transport and storage conditions in NOTES.

## 3. Switching capacity

Electrical Life	Resistive load	20 A, 250 V AC (cos $\phi$ = 1)	10 <sup>5</sup> (at 20 times/min.)
		Inductive load (cos $\phi$ = 0.7)	Inrush 70 A, Steady 20 A (250 V AC cos $\phi$ = 0.7)
	Inrush 80 A, Cut-off 80 A (When the motor is locked) (250 V AC cos $\phi$ = 0.7)		1.5 $\times 10^3$ (at 20 times/min.)

Note: Standard UL and CSA 1HP, 20A 250VAC 1 $\frac{1}{2}$ HP, 20A 125VAC

# REFERENCE DATA

## 1. Coil temperature rise

Place to be measured: Inside of coil  
Ambient temperature: 25°C 77°F

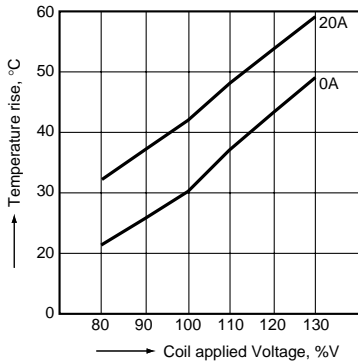

## 2. Life curve

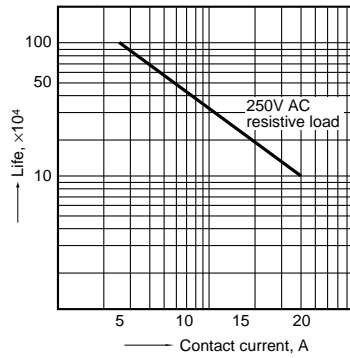

## 3. Operate/release time

Sample: JM1aN-TMP-DC24V-F, 5 pcs.

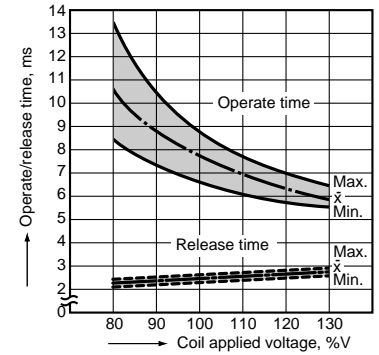

## 4. Ambient temperature characteristics

Sample: JM1aN-TMP-DC24V-F, 5 pcs.

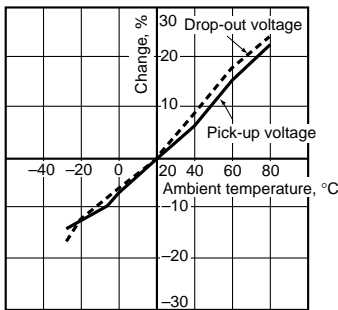

# DIMENSIONS (mm inch)

The CAD data of the products with a **CAD Data** mark can be downloaded from: <http://industrial.panasonic.com/ac/e/>

Flat TMP type

**CAD Data**

External dimensions

Schematic

PC board pattern (Bottom view)

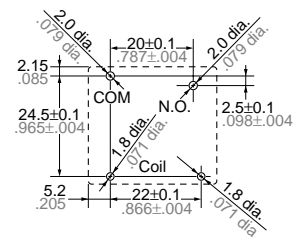
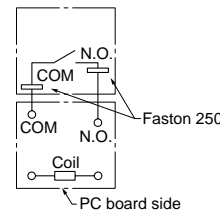
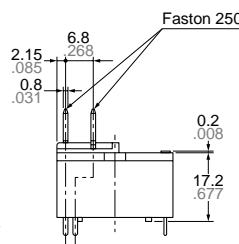
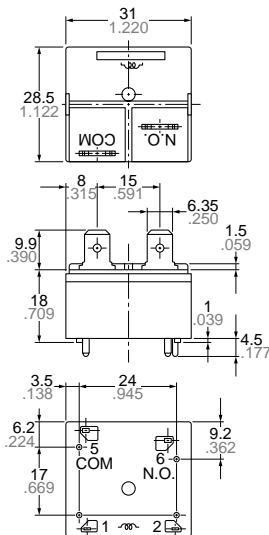

Tolerance: ±0.1 ±.004

General tolerance: ±0.4 ±.016

Flat TM type

**CAD Data**



External dimensions

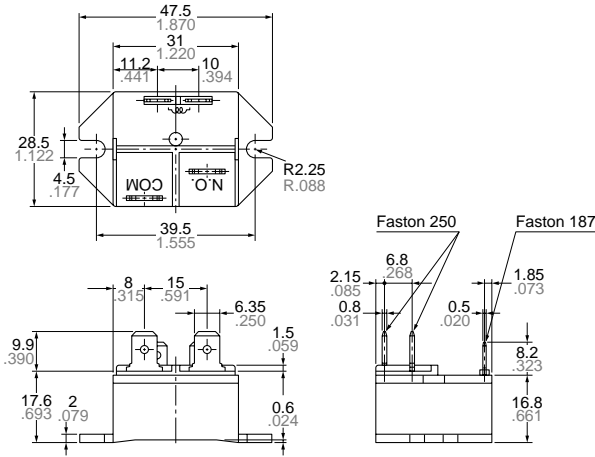

Schematic

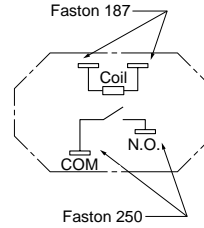

Panel cutout

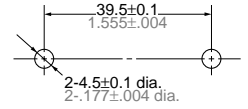

General tolerance:  $\pm 0.4 \pm 0.16$

Slim TMP type

**CAD Data**



External dimensions

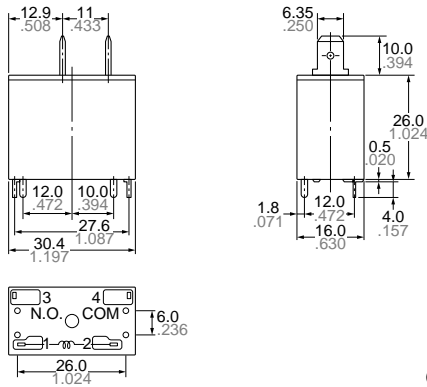

Schematic

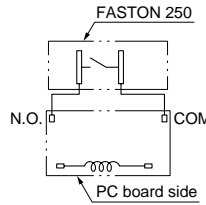

PC board pattern (Copper-side view)

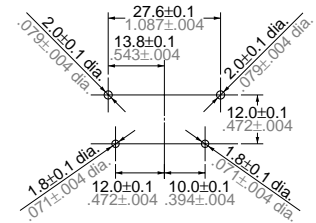

Tolerance:  $\pm 0.1 \pm 0.04$

General tolerance:  $\pm 0.4 \pm 0.16$

Slim PCB type

**CAD Data**



External dimensions

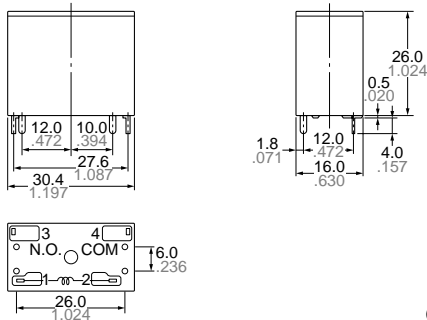

Schematic

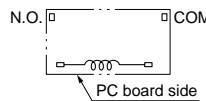

PC board pattern (Copper-side view)

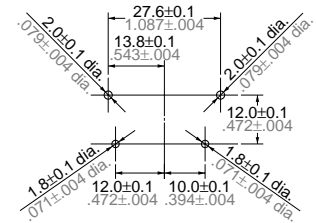

Tolerance:  $\pm 0.1 \pm 0.04$

General tolerance:  $\pm 0.4 \pm 0.16$

**SAFETY STANDARDS**

Item	UL/C-UL (Recognized)		CSA (Certified)		VDE (Certified)	
	File No.	Contact rating	File No.	Contact rating	File No.	Contact rating
Slim type	E43028	20A 125V AC 20A 250V AC 1½HP 125V AC 1HP 250V AC	LR26550	20A 125V AC 20A 250V AC 1½HP 125V AC 1HP 250V AC	40014275	20A 250V AC (cosφ=1.0) 12A 220V AC (cosφ=0.4)
Flat type	E43028	20A 125V AC 20A 250V AC 1½HP 125V AC 1HP 250V AC	LR26550	20A 125V AC 20A 250V AC 1½HP 125V AC 1HP 250V AC	40014275	20A 250V AC (cosφ=1.0) 12A 230V AC (cosφ=0.4)

**For Cautions for Use.**